

# ML-138 Quick Release Buckle



BOLT



3M STICKER



ALLEN KEY

∅22.2mm~25.4mm  
SECURE BRACKET

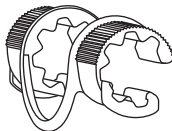

>∅25.4mm~∅31.8mm  
SECURE BRACKET

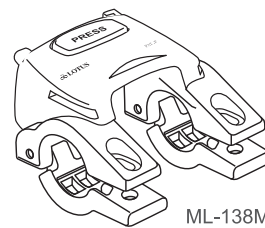
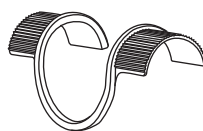

ML-138M

## Instructions

### Step: 1

Place the 3M sticker, then place the secure bracket to handlebar under the stem. Please note that the plastic line of secure bracket must be against the stem as illustrated.

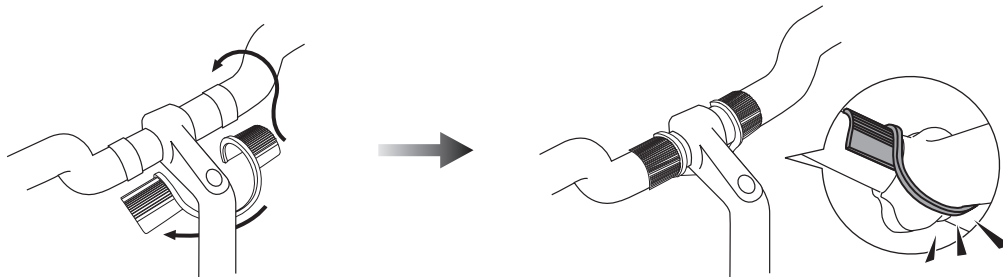

### Step: 2

Install the ML-138M QR buckle to handlebar in about 45 degree.

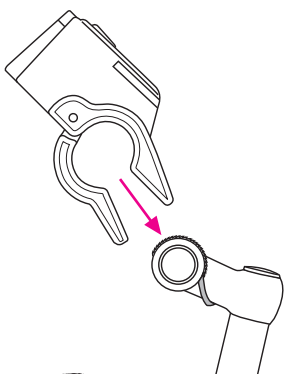

### Step: 3

Close the clamps, and then use the allen key to screw the bolts to slightly tight.

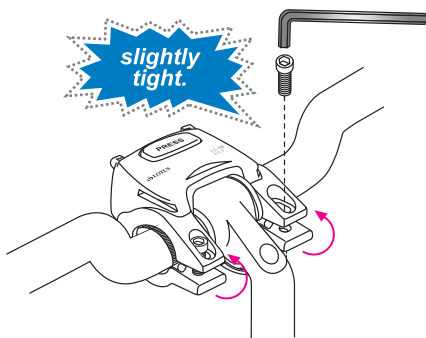

### Step: 4

Push the ML-138M QR buckle down to the desire position.  
Use the Allen key again to screw the bolts to sufficiently tight as illustrated.

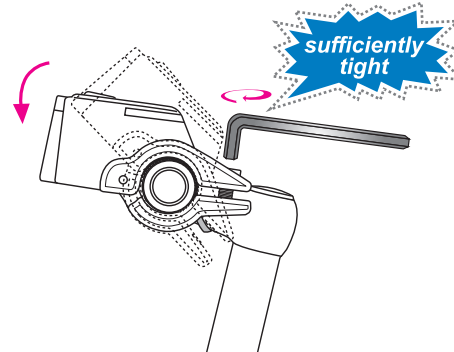

### Step: 5

LT-98LS is an optional item.

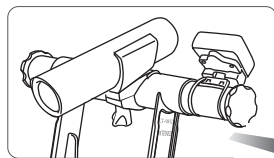

Light Stand (LT-98LS)

LT-98LS is an extension that allows more accessories to be fitted when using the ML-138M bracket.

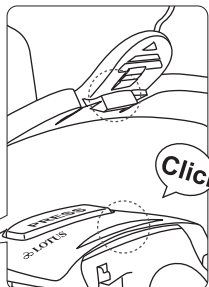

Slide the light stand into the ML-138M bracket until it clicks in place, as illustrated.

To remove the light stand, pull the tab upwards and slide the fitting out of the ML-138M bracket.

### Step: 6

Your bracket is now properly installed. Position your bag/basket with the receiving plate (A) facing the handlebar bracket (B). Carefully mate the two components and then slide the bag/basket downwards until it clicks in place.

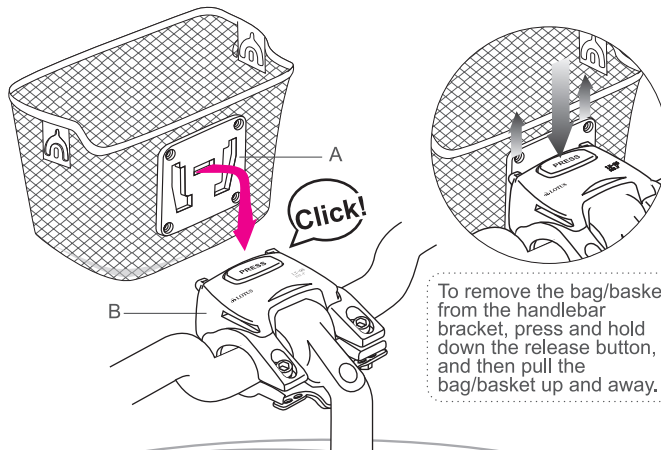

To remove the bag/basket from the handlebar bracket, press and hold down the release button, and then pull the bag/basket up and away.

ML-138M

## Warning:

Do not load more than 6kg into handlebar bag or basket, as this can affect steering. Ensure all brake and gear cables functions correctly after fitting.

Can not be used under temperature of -4°F / -20°C